

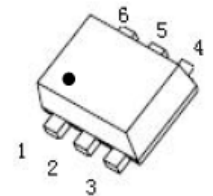

FEATURE

- Epitaxial planar die construction
- Ideal for low power amplification and switching

MARKING KAP

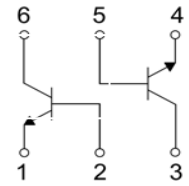

SOT-563

MAXIMUM RATINGS ($T_a=25^{\circ}\text{C}$ unless otherwise noted)

Symbol	Parameter	Value	Unit
V_{CB0}	Collector-Base Voltage	60	V
V_{CEO}	Collector-Emitter Voltage	40	V
V_{EBO}	Emitter-Base Voltage	5	V
I_C	Collector Current -Continuous	0.2	A
P_C	Collector Power Dissipation	0.2	W
T_J, T_{stg}	Operation Junction and Storage Temperature Range	-55~+150	$^{\circ}\text{C}$

ELECTRICAL CHARACTERISTICS ($T_a=25^{\circ}\text{C}$ unless otherwise specified)

Parameter	Symbol	Test conditions	Min	Typ	Max	Unit
Collector-base breakdown voltage	$V_{(BR)CBO}$	$I_C=10\mu\text{A}, I_E=0$	60			V
Collector-emitter breakdown voltage	$V_{(BR)CEO}$	$I_C=1\text{mA}, I_B=0$	40			V
Emitter-base breakdown voltage	$V_{(BR)EBO}$	$I_E=10\mu\text{A}, I_C=0$	5			V
Collector cut-off current	I_{CBO}	$V_{CB}=30\text{V}, I_E=0$			0.05	μA
Emitter cut-off current	I_{EBO}	$V_{EB}=5\text{V}, I_C=0$			0.05	μA
Collector cut-off current	I_{CEX}	$V_{CE}=30\text{V}, V_{BE(off)}=3\text{V}$			0.05	μA
DC current gain	$h_{FE(1)}$	$V_{CE}=1\text{V}, I_C=0.1\text{mA}$	40			
	$h_{FE(2)}$	$V_{CE}=1\text{V}, I_C=1\text{mA}$	70			
	$h_{FE(3)}$	$V_{CE}=1\text{V}, I_C=10\text{mA}$	100		300	
	$h_{FE(4)}$	$V_{CE}=1\text{V}, I_C=50\text{mA}$	60			
	$h_{FE(5)}$	$V_{CE}=1\text{V}, I_C=100\text{mA}$	30			
Collector-emitter saturation voltage	$V_{CE(sat)1}$	$I_C=10\text{mA}, I_B=1\text{mA}$			0.2	V
	$V_{CE(sat)2}$	$I_C=50\text{mA}, I_B=5\text{mA}$			0.3	V
Base-emitter saturation voltage	$V_{BE(sat)1}$	$I_C=10\text{mA}, I_B=1\text{mA}$	0.65		0.85	V
	$V_{BE(sat)2}$	$I_C=50\text{mA}, I_B=5\text{mA}$			0.95	V
Transition frequency	f_T	$V_{CE}=20\text{V}, I_C=10\text{mA}, f=100\text{MHz}$	300			MHz
Collector output capacitance	C_{ob}	$V_{CB}=5\text{V}, I_E=0, f=1\text{MHz}$				pF
Delay time	t_d	$V_{CC}=3\text{V}, V_{BE(off)}=-0.5\text{V}$			35	ns
Rise time	t_r	$I_C=10\text{mA}, I_{B1}=-I_{B2}=1\text{mA}$			35	ns
Storage time	t_s	$V_{CC}=3\text{V}, I_C=10\text{mA}$			200	ns
Fall time	t_f	$I_{B1}=-I_{B2}=1\text{mA}$			50	ns



Typical Characteristics

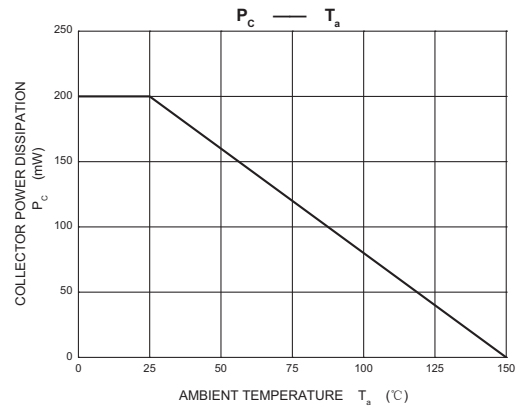
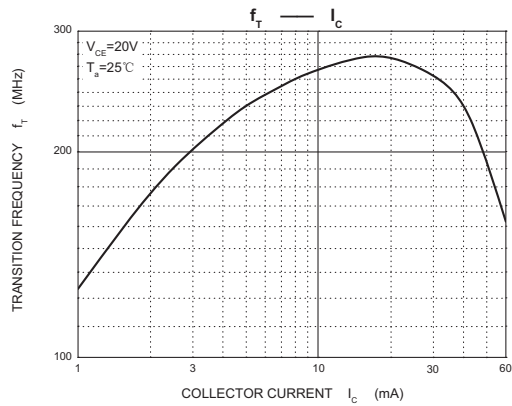
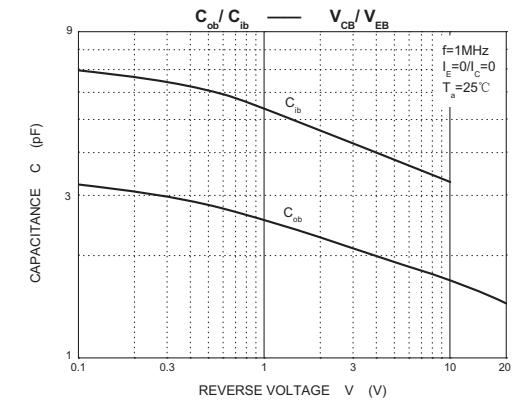
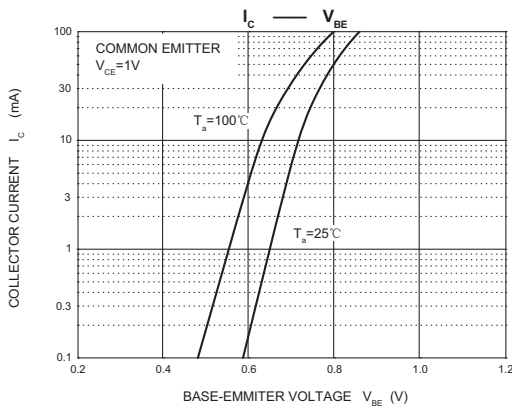
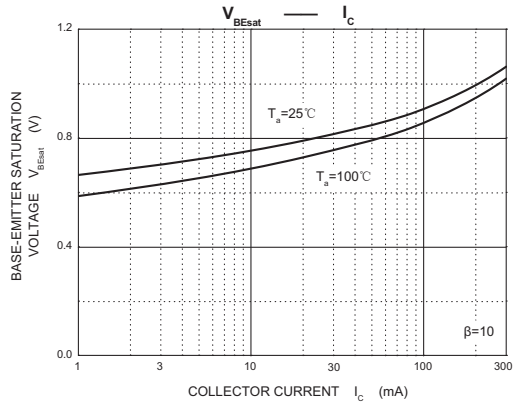
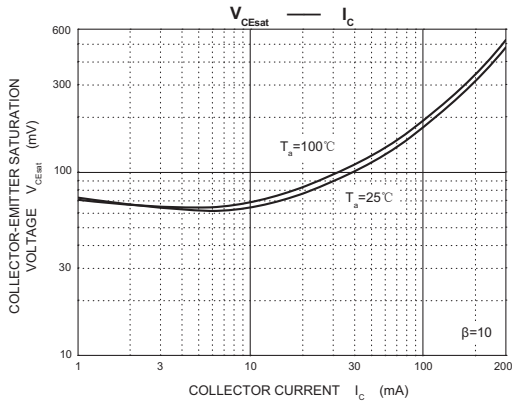
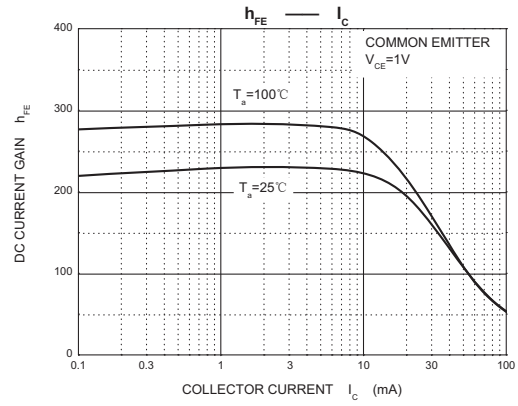
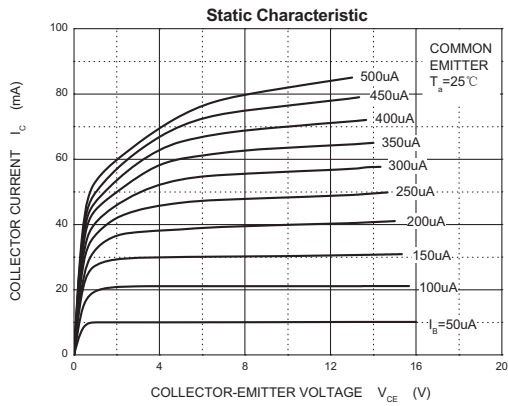



SOT-563 Package Outline Dimensions

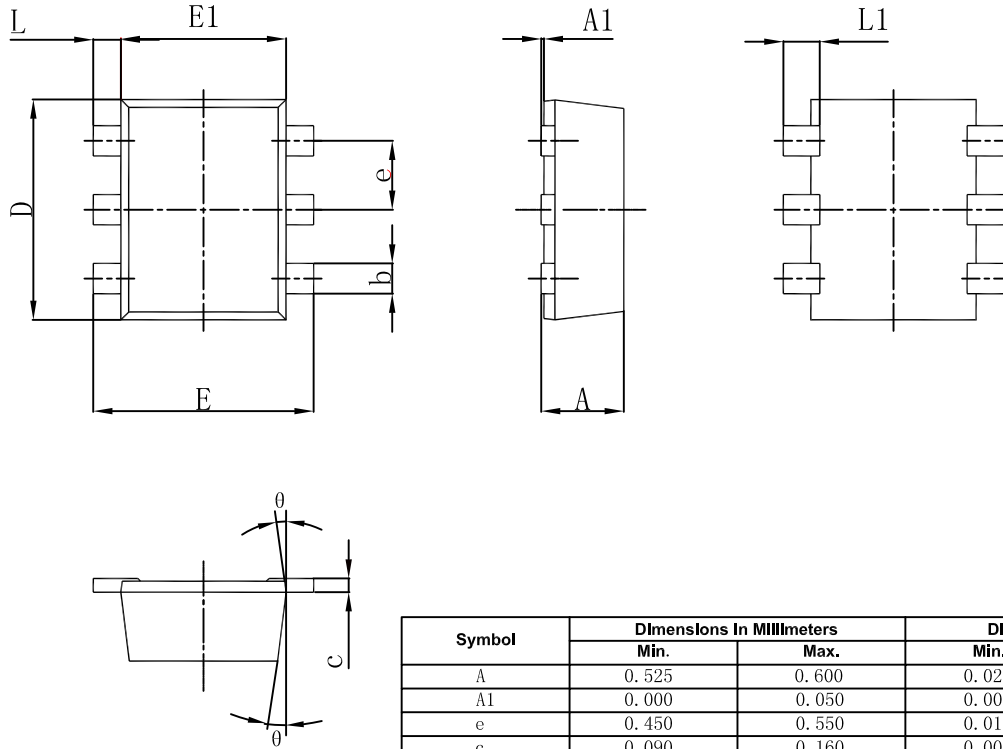

Symbol	Dimensions In Millimeters		Dimensions In Inches	
	Min.	Max.	Min.	Max.
A	0.525	0.600	0.021	0.024
A1	0.000	0.050	0.000	0.002
e	0.450	0.550	0.018	0.022
c	0.090	0.160	0.004	0.006
D	1.500	1.700	0.059	0.067
b	0.170	0.270	0.007	0.011
E1	1.100	1.300	0.043	0.051
E	1.500	1.700	0.059	0.067
L	0.100	0.300	0.004	0.012
L1	0.200	0.400	0.008	0.016
θ	7 ⁰ REF.		7 ⁰ REF.	

SOT-563 Suggested Pad Layout

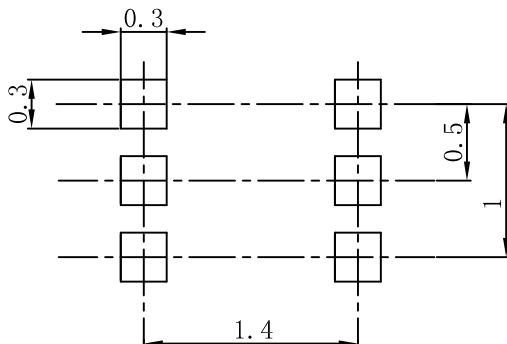

Note:

1. Controlling dimension: in millimeters.
2. General tolerance: $\pm 0.05\text{mm}$.
3. The pad layout is for reference purposes only.



SOT-563 Embossed Carrier Tape

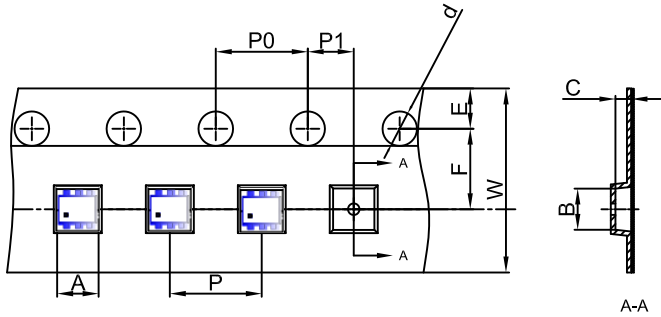

Packaging Description:
 SOT-563 parts are shipped in tape. The carrier tape is made from a dissipative (carbon filled) polycarbonate resin. The cover tape is a multilayer film (Heat Activated Adhesive in nature) primarily composed of polyester film, adhesive layer, sealant, and anti-static sprayed agent. These reeled parts in standard option are shipped with 3,000 units per 7" or 17.8cm diameter reel. The reels are clear in color and is made of polystyrene plastic (anti-static coated).

Dimensions are in millimeter

Pkg type	A	B	C	d	E	F	P0	P	P1	W
SOT-563	1.78	1.78	0.69	Ø1.50	1.75	3.50	4.00	4.00	2.00	8.00

SOT-563 Tape Leader and Trailer

